

0.4_{mm}Pitch

Series 5846

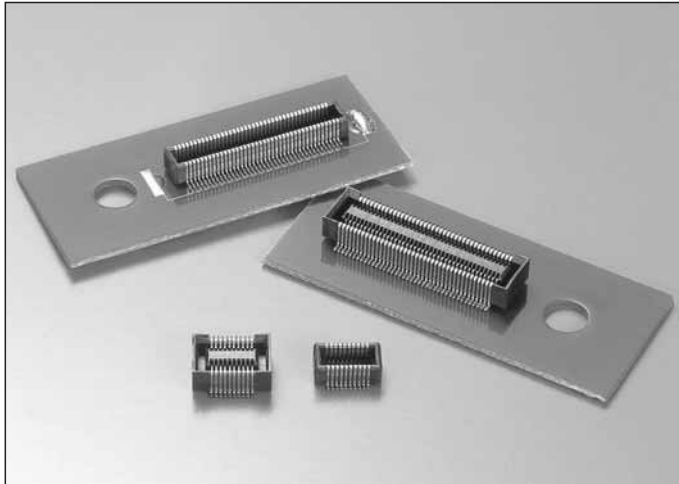

シリーズ (Series)	5846
基板間高さ (Stacking Height)	3.0mm
極間隔 (Pitch)	0.4mm
極数 (No. of Positions)	20 ~ 80
定格電流 (Rated Current)	AC/DC 0.4A
定格電圧 (Rated Voltage)	AC/DC 50V
耐電圧 (D.W.Voltage)	AC 250Vrms/min.
コンタクト材質 (Contact Material)	銅合金 Copper alloy
インシュレータ材質 (Insulator Material)	耐熱樹脂 Heat-resistant plastic
使用温度範囲 (Operating Temperature)	- 40 ~ 85

SERIES 5846

概要

5846シリーズは、薄型ノートパソコン、モバイル機器等の市場の高密度実装の要求と小型化の要求に応えるべく開発された、0.4mmピッチの基板対基板コネクタです。基板間高さ3.0mm、端子を含めた幅寸法は5.8mm。

Outline

Series 5846 is a 0.4mm pitch Board to Board connector to meet the market requirement for high density package and downsizing tendency in laptop PCs, mobile devices, and etc. It achieves 3.0mm of the stacking height and 5.8mm in width including leads.

特長

- (1) コネクタ裏面は底壁が形成されておりコンタクトの露出がないため、基板配線との短絡もなく配線設計を自由に行うことができます。
- (2) 高い接触信頼性を実現するために、接触構造は振動や落下衝撃に強い挟み込み構造を採用するとともに、接触部は飛散したフラックスや付着した異物を排除する独自接点構造を採用しました。
- (3) 嵌合構造は「FINE-LOCK構造」に加え「振り子バネ構造」を採用し、優れたクリック感で嵌合力は低く、高い嵌合保持力を実現しました。
- (4) 実装工程で使用いただけるチェッカー専用コネクタもご用意しました。

Features

- (1) Since the bottom of the connector is covered with a plate and no contact is exposed, which assures the connector of being free from a short circuit caused with the printed wire on the board.
- (2) The pinching structure, highly resistant to vibration and drop shock, is adopted in contacts and the original structure excluding splashed flux or foreign matters attached is adopted on contacting points in order to obtain high contacting reliability.
- (3) "Pendulum spring structure" as well as "FINE-LOCK structure" is adopted to the mating system, which achieves the excellent clicking feeling, low mating force and high retaining force.
- (4) A checker connector to be mated with a connector is also available to check electrical continuity or short circuit of the connector.

本カタログには推奨めっきを掲載しております。めっき種類・仕様、ならびに生産対応可能極数については営業部に御確認願います。
Recommended plating types are mentioned in this catalogue.
For other plating types and their specifications, and available numbers of positions, please feel free to contact our sales department.

0.4mm Pitch

SERIES

5846

プラグ ST SMT
Plug Vertical SMT

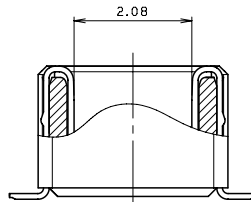
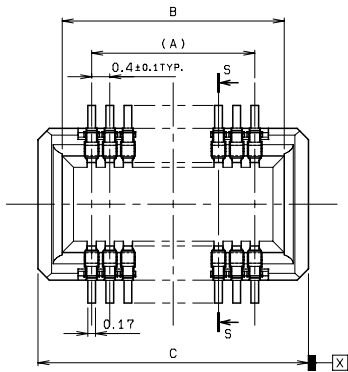

SECT. S-S

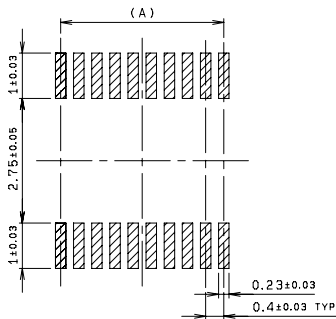
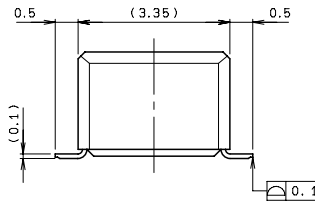
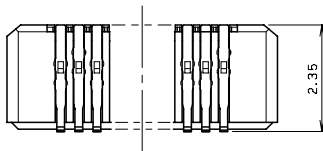

MOUNTING LAYOUT

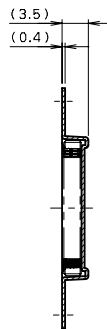
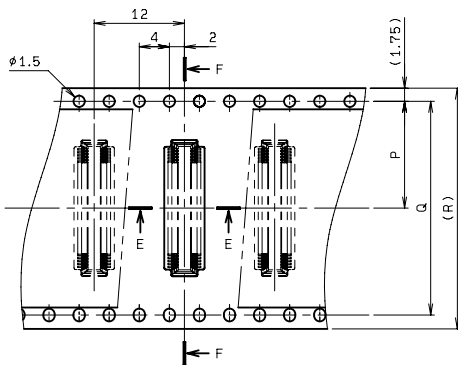

SECT. F-F

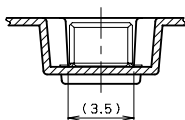

SECT. E-E

種数 NO. OF POS.	A	B	C
20	3.6	4.9	5.97
30	5.6	6.9	7.97
40	7.6	8.9	9.97
50	9.6	10.9	11.97
60	11.6	12.9	13.97
70	13.6	14.9	15.97
80	15.6	16.9	17.97

種数 NO. OF POS.	P	Q	R
20	7.5	-	16
30	7.5	-	16
40	11.5	-	24
50	11.5	-	24
60	11.5	-	24
70	11.5	-	24
80	14.2	28.4	32

注文コード ORDERING CODE

14 5846 OXX 000 829+

RoHS対応品

RoHS Compliant Product

極数 Number of positions

注) 生産可能極数については営業部にご確認願います。
Note) Feel free to contact our sales department for available numbers of positions.

梱包数量 : 1000個/リール

PACKING QUANTITY : 1000/Reel

0.4mm Pitch

SERIES

5846

リセ ST SMT
Receptacle Vertical SMT

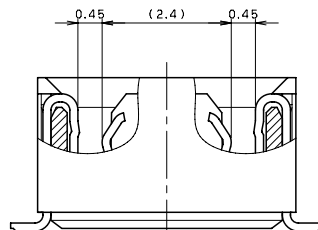
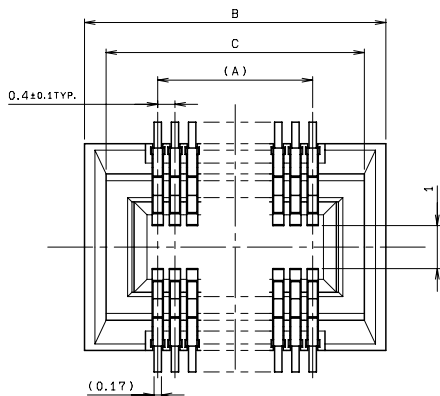

SECT. S-S

極数 NO. OF POS.	A	B	C
20	3.6	7.0	6.0
30	5.6	9.0	8.0
40	7.6	11.0	10.0
50	9.6	13.0	12.0
60	11.6	15.0	14.0
70	13.6	17.0	16.0
80	15.6	19.0	18.0

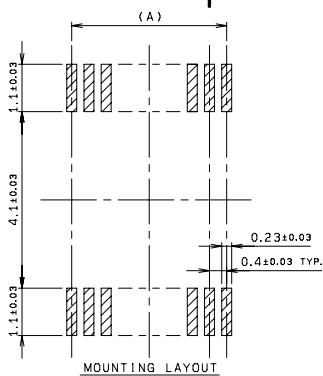
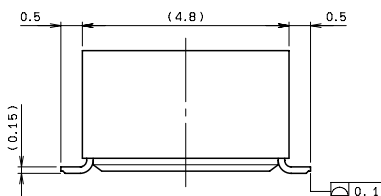
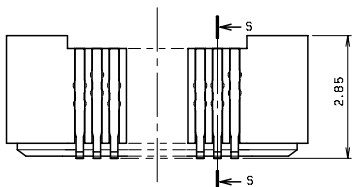

MOUNTING LAYOUT

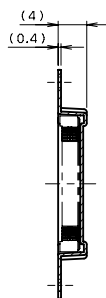
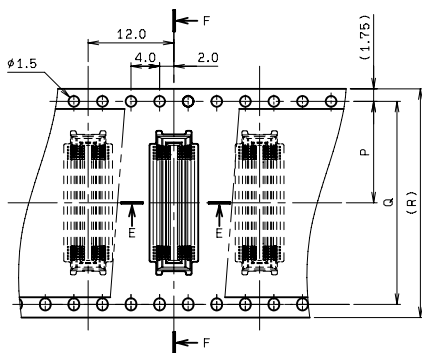

SECT. F-F

極数 NO. OF POS.	P	Q	R
20	7.5	-	16
30	7.5	-	16
40	11.5	-	24
50	11.5	-	24
60	11.5	-	24
70	11.5	-	24
80	14.2	28.4	32

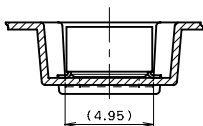

SECT. E-E

注) 生産可能極数については営業部にご確認願います。
Note) Feel free to contact our sales department for available numbers of positions.

梱包数量 : 1000個/リール
PACKING QUANTITY : 1000/Reel

注文コード ORDERING CODE

24 5846 OXX 000 829+

RoHS 対応品

RoHS Compliant Product

極数 Number of positions